

VCOM: 3.52V  
AVDD: 8.9V  
VGL: 1.5V  
VGH: -6.9V

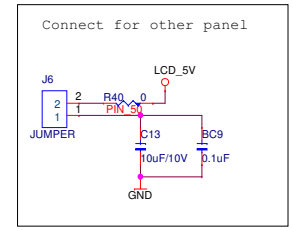
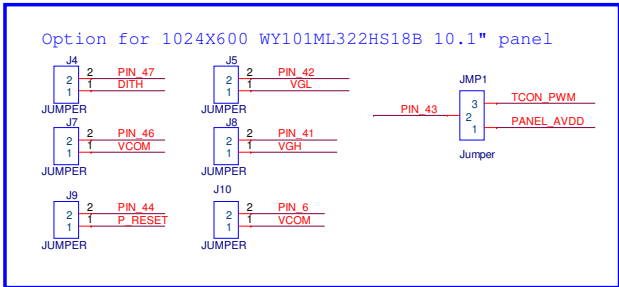
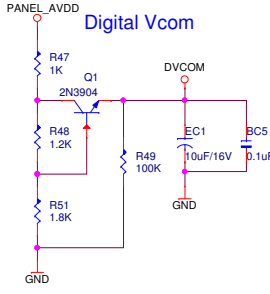
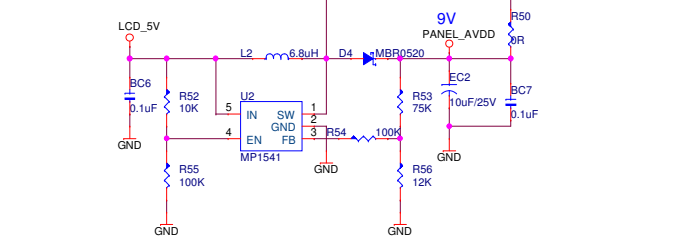
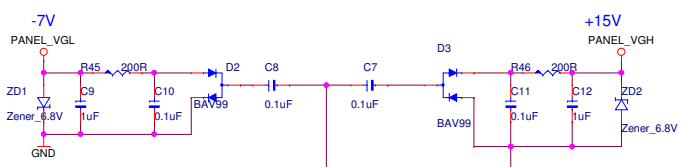
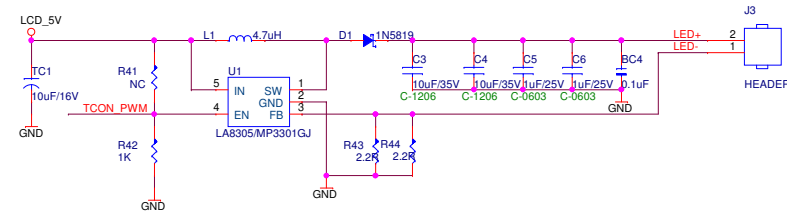
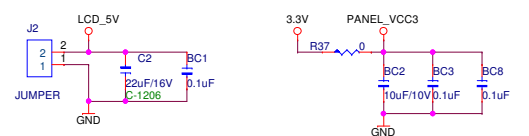
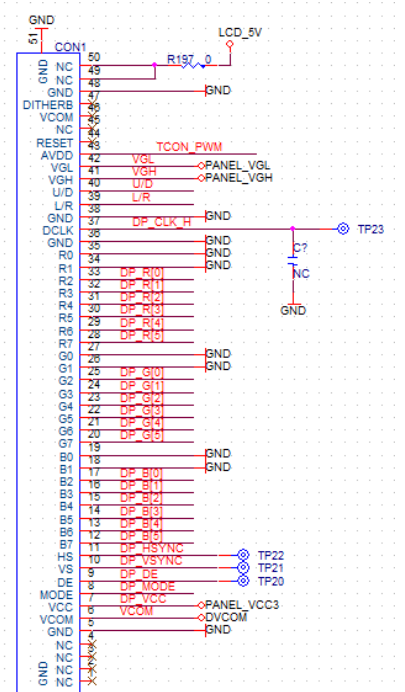
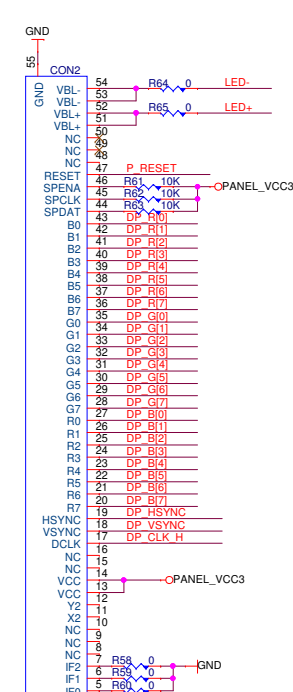

Title	<Title>	
Size	Document Number	Rev
Custom	<Doc>	<Rev>
Date:	Tuesday, May 28, 2019	Sheet 1 of 1